



OWNER'S MANUAL  
USO E MANUTENZIONE  
MANUAL DEL PROPIETARIO



**CBR125R**

\*note - increase in size of the exhaust pipe per percentage of length of the bar at the top  
(recommended 10%)

# Honda CBR125R

## OWNER'S MANUAL

## USO E MANUTENZIONE

## MANUAL DEL PROPIETARIO

© Honda Motor Co., Ltd. 2003

### IMPORTANT INFORMATION

#### • OPERATOR AND PASSENGER

This motorcycle is designed to carry the operator and one passenger. Never exceed the maximum weight capacity as shown on the accessories and loading label.

#### • ON-ROAD USE

This motorcycle is designed to be used only on the road.

#### • READ THIS OWNER'S MANUAL CAREFULLY

Pay special attention to the safety messages that appear throughout the manual. These messages are fully explained in the "A Few Words About Safety" section which appears before the Contents page.

This manual should be considered a permanent part of the motorcycle and should remain with the motorcycle when resold.

### Honda CBR125R OWNER'S MANUAL

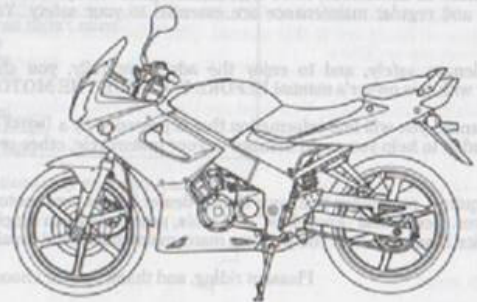

All information in this publication is based on the latest production information available at the time of approval for printing. Honda Motor Co., Ltd. reserves the right to make changes at any time without notice and without incurring any obligation.

No part of this publication may be reproduced without written permission.

## WELCOME INFORMATION

The motorcycle presents you a challenge to master the machine, a challenge to adventure. You ride through the wind, linked to the road by a vehicle that responds to your commands as no other does. Unlike an automobile, there is no metal cage around you. Like an airplane, a pre-ride inspection and regular maintenance are essential to your safety. Your reward is freedom.

To meet the challenges safely, and to enjoy the adventure fully, you should become thoroughly familiar with this owner's manual **BEFORE YOU RIDE THE MOTORCYCLE**.

As you read this manual, you will find information that is preceded by a **(notice)** symbol. This information is intended to help you avoid damage to your motorcycle, other property, or the environment.

When service is required, remember that your Honda dealer knows your motorcycle best. If you have the required mechanical "know-how" and tools, your dealer can supply you with an official Honda Service Manual to help you perform many maintenance and repair tasks.

Pleasant riding, and thank you for choosing a Honda!

## A FEW WORDS ABOUT SAFETY

The following codes in this manual indicate each country.

E	UK
F	France
ED	European direct sales
	Austria
	Belgium
	Germany
	Italy
	Portugal
	Spain
	Switzerland

The specifications may vary with each locale.

## A FEW WORDS ABOUT SAFETY

Your safety, and the safety of others, is very important. And operating this motorcycle safely is an important responsibility.

To help you make informed decisions about safety, we have provided operating procedures and other information on labels and in this manual. This information alerts you to potential hazards that could hurt you or others.

Of course, it is not practical or possible to warn you about all hazards associated with operating or maintaining a motorcycle. You must use your own good judgment.

You will find important safety information in a variety of forms, including:

- **Safety Labels** — on the motorcycle.
- **Safety Messages** — preceded by a safety alert symbol **▲** and one of three signal words: **DANGER, WARNING, or CAUTION**.

These signal words mean:

**▲ DANGER** You **WILL** be **KILLED** or **SERIOUSLY HURT** if you don't follow instructions.

**▲ WARNING** You **CAN** be **KILLED** or **SERIOUSLY HURT** if you don't follow instructions.

**▲ CAUTION** You **CAN** be **HURT** if you don't follow instructions.

- **Safety Headings** — such as Important Safety Reminders or Important Safety Precautions.
- **Safety Section** — such as Motorcycle Safety.
- **Instructions** — how to use this motorcycle correctly and safely.

This entire manual is filled with important safety information — please read it carefully.

## OPERATION ABOUT SAFETY

page		page	
1	<b>MOTORCYCLE SAFETY</b>	32	<b>ESSENTIAL INDIVIDUAL COMPONENTS</b>
1	Important Safety Information	32	Ignition Switch
2	Protective Apparel	33	Keys
4	Load Limits and Guidelines	34	Right Handlebar Controls
		35	Left Handlebar Controls
8	<b>PARTS LOCATION</b>		
11	Instruments and Indicators		
16	<b>MAJOR COMPONENTS</b> (Information you need to operate this motorcycle)		
16	Brakes		
18	Clutch		
20	Coolant		
22	Fuel		
25	Engine Oil		
26	Tubeless Tyres		

## MOTORCYCLE SAFETY

page	
36	<b>FEATURES</b> (Not required for operation)
36	Steering Lock
37	Seat
39	Helmet Holder
40	Document Bag
41	Middle Cowl
42	Headlight Aim Vertical Adjustment

## MAINTENANCE

page	
43	<b>OPERATION</b>
43	Pre-ride Inspection
45	Starting the Engine
49	Running-in
50	Riding
52	Braking
53	Parking
54	Anti-theft Tips

## MAINTENANCE

page		page	
55	<b>MAINTENANCE</b>	88	Battery
55	The Importance of Maintenance	90	Fuse Replacement
56	Maintenance Safety	93	Stoplight Switch Adjustment
57	Safety Precautions	94	Bulb Replacement
58	Maintenance Schedule	100	<b>CLEANING</b>
61	Tool Kit	104	<b>STORAGE GUIDE</b>
62	Serial Numbers	104	Storage
63	Colour Label	106	Removal from Storage
64	Crankcase Breather	107	<b>SPECIFICATIONS</b>
65	Engine Oil	111	<b>CATALYTIC CONVERTER</b>
68	Spark Plugs		
71	Throttle Operation		
72	Idle Speed		
73	Coolant		
74	Drive Chain		
80	Front and Rear Suspension Inspection		
81	Side Stand		
82	Wheel Removal		
86	Brake Pad Wear		

## MOTORCYCLE SAFETY

### IMPORTANT SAFETY INFORMATION

Your motorcycle can provide many years of service and pleasure — if you take responsibility for your own safety and understand the challenges that you can meet on the road.

There is much that you can do to protect yourself when you ride. You'll find many helpful recommendations throughout this manual. Following are a few that we consider most important.

#### Always Wear a Helmet

It's a proven fact: helmets significantly reduce the number and severity of head injuries. So always wear an approved motorcycle helmet and make sure your passenger does the same. We also recommend that you wear eye protection, sturdy boots, gloves, and other protective gear (page 2).

### Make Yourself Easy to See

Some drivers do not see motorcycles because they are not looking for them. To make yourself more visible, wear bright reflective clothing, position yourself so other drivers can see you, signal before turning or changing lanes, and use your horn when it will help others notice you.

### Ride Within Your Limits

Pushing the limits is another major cause of motorcycle accidents. Never ride beyond your personal abilities or faster than conditions warrant. Remember that alcohol, drugs, fatigue and inattention can significantly reduce your ability to make good judgements and ride safely.

## ENTRANCE

### Don't Drink and Ride

Alcohol and riding don't mix. Even one drink can reduce your ability to respond to changing conditions, and your reaction time gets worse with every additional drink. So don't drink and ride, and don't let your friends drink and ride either.

### Keep Your Bike in Safe Condition

For safe riding, it's important to inspect your motorcycle before every ride and perform all recommended maintenance. Never exceed load limits, and only use accessories that have been approved by Honda for this motorcycle. See page 4 for more details.

- Tires and Rear Suspension
- Inspection
- Side Stand
- Front Suspension
- Brake Pad Wear

## MOTORCYCLE SAFETY

### PROTECTIVE APPAREL

For your safety, we strongly recommend that you always wear an approved motorcycle helmet, eye protection, boots, gloves, long pants, and a long-sleeved shirt or jacket whenever you ride. Although complete protection is not possible, wearing proper gear can reduce the chance of injury when you ride.

Following are suggestions to help you choose proper gear.

### ⚠ WARNING

Not wearing a helmet increases the chance of serious injury or death in a crash.

Be sure you and your passenger always wear a helmet, eye protection and other protective apparel when you ride.

### Helmets and Eye Protection

Your helmet is your most important piece of riding gear because it offers the best protection against head injuries. A helmet should fit your head comfortably and securely. A bright-coloured helmet can make you more noticeable in traffic, as can reflective strips.

An open-face helmet offers some protection, but a full-face helmet offers more. Always wear a face shield or goggles to protect your eyes and help your vision.

### Additional Riding Gear

In addition to a helmet and eye protection, we also recommend:

- Sturdy boots with non-slip soles to help protect your feet and ankles.
- Leather gloves to keep your hands warm and help prevent blisters, cuts, burns and bruises.
- A motorcycle riding suit or jacket for comfort as well as protection. Bright-coloured and reflective clothing can help make you more noticeable in traffic. Be sure to avoid loose clothes that could get caught on any part of your motorcycle.

## LOAD LIMITS AND GUIDELINES

Your motorcycle has been designed to carry you and one passenger. When you carry a passenger, you may feel some difference during acceleration and braking. But so long as you keep your motorcycle well-maintained, with good tyres and brakes, you can safely carry loads within the given guidelines.

However, exceeding the weight limit or carrying an unbalanced load can seriously affect your motorcycle's handling, braking and stability. Non-Honda accessories, improper modifications, and poor maintenance can also reduce your safety margin.

The following pages give more specific information on loading, accessories and modifications.

### Loading

How much weight you put on your motorcycle, and how you load it, are important to your safety. Anytime you ride with a passenger or cargo you should be aware of the following information.

### ⚠ WARNING

Overloading or improper loading can cause a crash and you can be seriously hurt or killed.

Follow all load limits and other loading guidelines in this manual.

Be sure you and your passenger always wear a helmet, eye protection and other protective apparel when you ride.

### Load Limits

Following are the load limits for your motorcycle:

**Maximum weight capacity:**  
180 kg (397 lbs)

Includes the weight of the rider, passenger, all cargo and all accessories  
**Maximum cargo weight:**  
8 kg (18 lbs)

The weight of added accessories will reduce the maximum cargo weight you can carry.

Always use proper tie-down technique when loading your motorcycle. Do not exceed the maximum weight capacity of your motorcycle's electrical system.

Always use proper tie-down technique when loading your motorcycle. Do not exceed the maximum weight capacity of your motorcycle's electrical system.

### Loading Guidelines

Your motorcycle is primarily intended for transporting you and a passenger. You may wish to secure a jacket or other small items to the seat when you are not riding with a passenger.

If you wish to carry more cargo, check with your Honda dealer for advice, and be sure to read the information regarding accessories on page 6.

Restoring or modifying your lights, gauges, engine control system or other equipment can also make your motorcycle illegal.

Follow these guidelines whenever you carry a passenger or cargo:

• Check that both tyres are properly inflated.

• Do not choose items from creating a hazard, make sure that all cargo is securely tied down before you ride away.

• Place cargo weight as close to the center of the motorcycle as possible.

• Balance cargo weight evenly on both sides.

Improper accessories and modifications can reduce your motorcycle's handling, braking, stability, and safety. Improper accessories, improper modifications, and poor maintenance can also reduce your safety.

The following pages give more specific details on loading, accessories and modifications.

### Accessories and Modifications

Modifying your motorcycle or using non-Honda accessories can make your motorcycle unsafe. Before you consider making any modifications or adding an accessory, be sure to read the following information.

#### **⚠ WARNING**

Improper accessories or modifications can cause a crash in which you can be seriously hurt or killed.

Follow all instructions in this owner's manual regarding accessories and modifications.

### Accessories

We strongly recommend that you use only genuine Honda accessories that have been specifically designed and tested for your motorcycle. Because Honda cannot test all other accessories, you must be personally responsible for proper selection, installation and use of non-Honda accessories. Check with your dealer for assistance and always follow these guidelines:

- Make sure the accessory does not obscure any lights, reduce ground clearance and banking angle, limit suspension travel or steering travel, alter your riding position or interfere with operating any controls.
- Be sure electrical equipment does not exceed the motorcycle's electrical system capacity (page 110). A blown fuse can cause a loss of lights or engine power.

- Do not pull a trailer or sidecar with your motorcycle. This motorcycle was not designed for these attachments, and their use can seriously impair your motorcycle's handling.

### Modifications

We strongly advise you not to remove any original equipment or modify your motorcycle in any way that would change its design or operation. Such changes could seriously impair your motorcycle's handling, stability and braking, making it unsafe to ride.

Removing or modifying your lights, mufflers, emission control system or other equipment can also make your motorcycle illegal.

## PARTS LOCATION

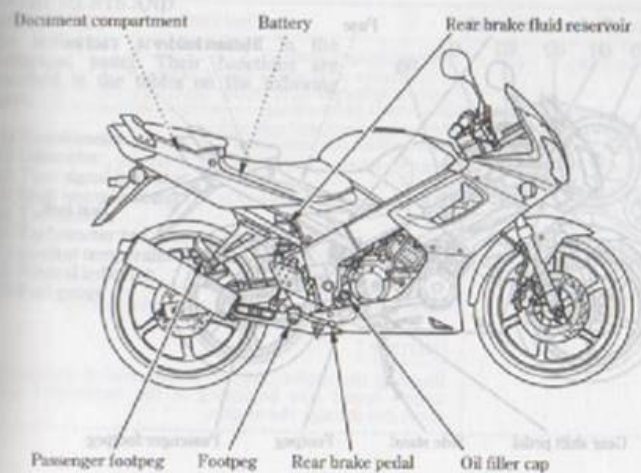
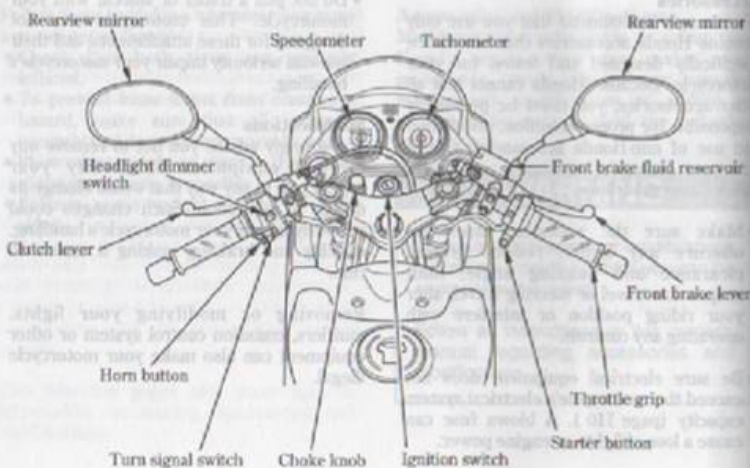

## PARTS LOCATION

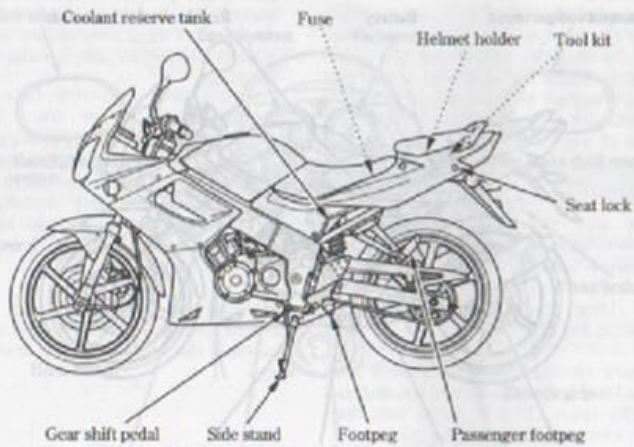

## INSTRUMENTS AND INDICATORS

The indicators are contained in the instrument panel. Their functions are described in the tables on the following pages.

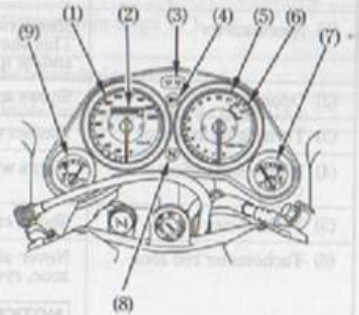

- (1) Speedometer
- (2) Odometer
- (3) Turn signal indicator
- (4) High beam indicator
- (5) Tachometer
- (6) Tachometer red zone
- (7) Coolant temperature gauge
- (8) Neutral indicator
- (9) Fuel gauge

### NOTICE

Running the engine beyond recommended maximum engine speed (the beginning of the tachometer red zone) can damage the engine.

(Ref.No.) Description	Function
(1) Speedometer	Shows riding speed. This shows your speed in kilometers per hour (km/h) and/or miles per hour (mph) depending on the type.
(2) Odometer	Shows accumulated mileage.
(3) Turn signal indicator	Flashes when either turn signal is operated.
(4) High beam indicator (blue)	Lights when the headlight is on high beam.
(5) Tachometer	Shows engine revolutions per minute.
(6) Tachometer red zone	Never allow the tachometer needle to enter the red zone, even after the engine has been broken in.
<p><b>NOTICE</b></p> <p>Running the engine beyond recommended maximum engine speed (the beginning of the tachometer red zone) can damage the engine.</p>	

(Ref.No.) Description	Function
(7) Coolant temperature gauge	Shows coolant temperature (page 15).
(8) Neutral indicator (green)	Lights when the transmission is in neutral.
(9) Fuel gauge	Shows approximate fuel supply available (page 14).

### Fuel Gauge

When the gauge needle enters the red band (2), fuel will be low and you should refill the tank as soon as possible. The amount of fuel left in the tank with the vehicle set upright when the needle enters the red band is approximately:

2.1 # (0.55 US gal, 0.46 Imp gal)



(1) Fuel gauge  
(2) Red band

#### NOTICE

Exceeding the engine's normal recommended maximum engine speed (the limit of the tachometer red band) can damage the engine.

### Coolant Temperature Gauge

When the needle begins to move above the C (Cold) mark, the engine is warm enough for the motorcycle to be ridden. The normal operating temperature range is within the section between the H and C marks. If the needle reaches the H and C marks, stop the engine and check the reserve tank coolant level. Read pages 20 - 21 and do not ride the motorcycle until the problem has been corrected.

#### NOTICE

Exceeding maximum running temperature may cause serious engine damage.

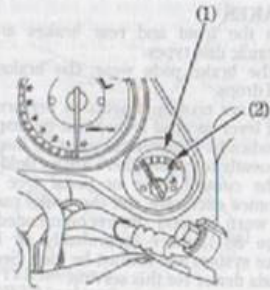

(1) Coolant temperature gauge  
(2) Red band

## MAJOR COMPONENTS

### (Information you need to operate this motorcycle)

#### BRAKES

Both the front and rear brakes are the hydraulic disc types.

As the brake pads wear, the brake fluid level drops.

There are no adjustments to perform, but fluid level and pad wear must be inspected periodically. The system must be inspected frequently to ensure there are no fluid leaks. If the control lever or pedal free travel becomes excessive and the brake pads are not worn beyond the recommended limit (page 86), there is probably air in the brake system and it must be bled. See your Honda dealer for this service.

#### Front Brake Fluid Level:

Lower the side stand, and with the handlebar straight ahead check the fluid level. It should be above the LOWER level mark (1). If the level is at or below the LOWER level mark (1), check the brake pads for wear (page 86).

Worn pads should be replaced. If the pads are not worn, have your brake system inspected for leaks.

The recommended brake fluid is Honda DOT 3 or DOT 4 brake fluid from a sealed container, or an equivalent.

#### Front



(1) LOWER level mark

#### Rear Brake Fluid Level:

With the motorcycle in an upright position, check the fluid level. It should be between the UPPER (1) and LOWER (2) level marks. If the level is at or below the LOWER level mark (2), check the brake pads for wear (page 87).

Worn pads should be replaced. If the pads are not worn, have your brake system inspected for leaks.

The recommended brake fluid is Honda DOT 3 or DOT 4 brake fluid from a sealed container, or an equivalent.

#### Rear



(1) UPPER level mark  
(2) LOWER level mark

#### Other Checks:

Make sure there are no fluid leaks. Check for deterioration or cracks in the hoses and fittings.

## CLUTCH

Clutch adjustment may be required if the motorcycle stalls when shifting into gear or tends to creep; or if the clutch slips, causing acceleration to lag behind engine speed. Minor adjustments can be made with the clutch cable adjuster (3) at the lever (1).

Normal clutch lever free play is:  
10–20 mm (0.4–0.8 in.)

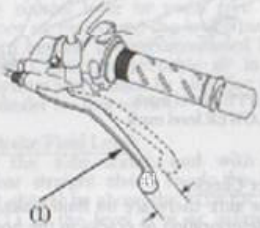

(1) Clutch lever

1. Loosen the lock nut (2) and turn the clutch cable adjuster (3). Tighten the lock nut (2) and check the adjustment.

2. If the adjuster is threaded out near its limit or if the correct free play cannot be obtained, loosen the lock nut (2) and turn in the clutch cable adjuster (3) completely. Tighten the lock nut (2).

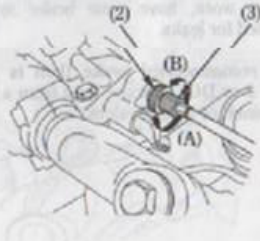

(2) Lock nut (A) Increase free play  
(3) Clutch cable adjuster (B) Decrease free play

3. Loosen the lock nut (5) at the lower end of the cable. Turn the adjusting nut (4) to obtain the specified free play. Tighten the lock nut (5) and check the adjustment.

4. Start the engine, pull in the clutch lever and shift into gear. Make sure the engine does not stall and the motorcycle does not creep. Gradually release the clutch lever and open the throttle. The motorcycle should begin to move smoothly and accelerate gradually.

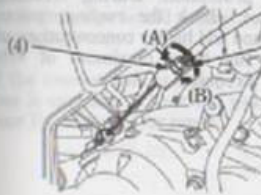

(4) Adjusting nut (A) Increase free play  
(5) Lock nut (B) Decrease free play

If proper adjustment cannot be obtained or the clutch does not work correctly, see your Honda dealer.

### Other Checks:

Check the clutch cable for kinks or signs of wear that could cause sticking or failure. Lubricate the clutch cable with a commercially available cable lubricant to prevent premature wear and corrosion.

## COOLANT

### Coolant Recommendation

The owner must properly maintain the coolant to prevent freezing, overheating, and corrosion. Use only high quality ethylene glycol antifreeze containing corrosion protection inhibitors specifically recommended for use in aluminum engines. (SEE ANTIFREEZE CONTAINER LABEL).

Use only low-mineral drinking water or distilled water as a part of the antifreeze solution. Water that is high in mineral content or salt may be harmful to the aluminum engine.

Using coolant with silicate inhibitors may cause premature wear of water pump seals or blockage of radiator passages. Using tap water may cause engine damage.

The factory provides a 50/50 solution of antifreeze and distilled water in this motorcycle. This coolant solution is recommended for most operating temperatures and provides good corrosion protection. A higher concentration of antifreeze decreases the cooling system performance and is recommended only when additional protection against freezing is needed. A concentration of less than 40/60 (40% antifreeze) will not provide proper corrosion protection. During freezing temperatures, check the cooling system frequently and add higher concentrations of antifreeze (up to a maximum of 60% antifreeze) if required.

### Inspection

The reserve tank is located below the front seat.

Check the coolant level in the reserve tank (1) while the engine is at the normal operating temperature with the motorcycle in an upright position. If the coolant level is below the LOWER level mark (3), remove the reserve tank cap (4) and add coolant mixture until it reaches the UPPER level mark (2). Always add coolant to the reserve tank.

Do not attempt to add coolant by removing the radiator cap.

If the reserve tank is empty, or if coolant loss is excessive, check for leaks and see your Honda dealer for repair.

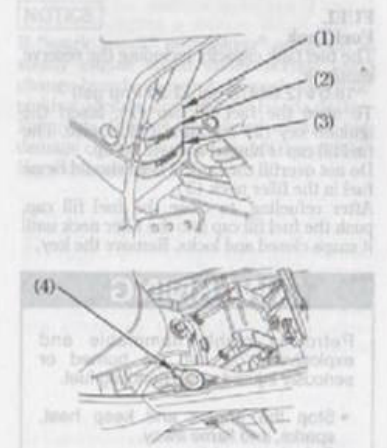

(1) Reserve tank (2) UPPER level mark (3) LOWER level mark (4) Reserve tank cap

## FUEL

### Fuel Tank

The fuel tank capacity including the reserve supply is:

10.0 l (2.64 US gal, 2.20 Imp gal)

To open the fuel fill cap (1), insert the ignition key (2) and turn it clockwise. The fuel fill cap is hinged and will lift up.

Do not overfill the tank. There should be no fuel in the filler neck (3).

After refueling, to close the fuel fill cap, push the fuel fill cap into the filler neck until it snaps closed and locks. Remove the key.

## ⚠ WARNING

Petrol is highly flammable and explosive. You can be burned or seriously injured when handling fuel.

- Stop the engine and keep heat, sparks, and flame away.
- Refuel only outdoors.
- Wipe up spills immediately.

22

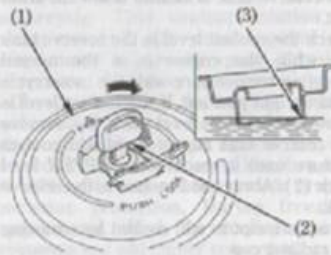

(1) Fuel fill cap  
(2) Ignition key

(3) Filler neck

Use unleaded petrol with a research octane number of 91 or higher.

The use of leaded petrol will cause premature damage to the catalytic converter.

## NOTICE

If "spark knock" or "pinking" occurs at a steady engine speed under normal load, change brands of petrol. If spark knock or pinking persists, consult your Honda dealer. Failure to do so is considered misuse, and damage caused by misuse is not covered by Honda's Limited Warranty.

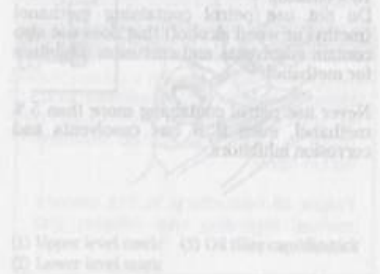

(1) Upper level mark (2) Lower level mark

23

## Petrol Containing Alcohol

If you decide to use a petrol containing alcohol (gasohol), be sure it's octane rating is at least as high as that recommended by Honda.

There are two types of "gasohol": one containing ethanol, and the other containing methanol.

Do not use petrol that contains more than 5% ethanol.

Do not use petrol containing methanol (methyl or wood alcohol) that does not also contain cosolvents and corrosion inhibitors.

Do not use petrol containing more than 5% methanol, even if it has cosolvents and corrosion inhibitors.

Petrol can be burned or seriously injured when handling fuel.

Stop the engine and keep heat, sparks, and flame away.

Refuel only outdoors.

Wipe up spills immediately.

## Fuel System Damage or Engine Performance

Problems resulting from the use of fuels that contain alcohol is not covered under the warranty. Honda cannot endorse the use of fuels containing methanol since evidence of their suitability is as yet incomplete.

Before buying fuel from an unfamiliar station, try to find out if the fuel contains alcohol. If it does, confirm the type and percentage of alcohol used. If you notice any undesirable operating symptoms while using a petrol that contains alcohol, or one that you think contains alcohol, switch to a petrol that you know does not contain alcohol.

(1) Fuel fill cap  
(2) Ignition key

(3) Filler neck

## ENGINE OIL

### Engine Oil Level Check

Check the engine oil level each day before starting the motorcycle.

1. Start the engine and let it idle for 3-5 minutes.

2. Stop the engine and hold the motorcycle in an upright position on firm, level ground.

3. After 2-3 minutes, remove the oil filler cap/dipstick (3), wipe it clean, and reinsert the oil filler cap/dipstick without screwing it in. Remove the oil filler cap/dipstick. The oil level should be between the upper (1) and lower (2) level marks on the oil filler cap/dipstick.

4. If required, add the specified oil (see page 65) up to the upper level mark. Do not overfill.

5. Reinstall the oil filler cap/dipstick. Check for oil leaks.

## NOTICE

Running the engine with insufficient oil pressure may cause serious engine damage.

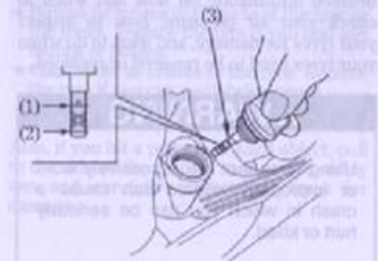

(1) Upper level mark (2) Lower level mark (3) Oil filler cap/dipstick

25

### TUBELESS TYRES

To safely operate your motorcycle, your tyres must be the proper type and size, in good condition with adequate tread, and correctly inflated for the load you are carrying. The following pages give more detailed information on how and when to check your air pressure, how to inspect your tyres for damage, and what to do when your tyres need to be repaired or replaced.

### WARNING

Using tyres that are excessively worn or improperly inflated can cause a crash in which you can be seriously hurt or killed.

Follow all instructions in this owner's manual regarding tyre inflation and maintenance.

### Air Pressure

Keeping your tyres properly inflated provides the best combination of handling, tread life and riding comfort. Generally, underinflated tyres wear unevenly, adversely affect handling, and are more likely to fail from being overheated. Overinflated tyres make your motorcycle ride more harshly, are more prone to damage from road hazards, and wear unevenly.

We recommend that you visually check your tyres before every ride and use a gauge to measure air pressure at least once a month or any time you think the tyres might be low.

Tubeless tyres have some self-sealing ability if they are punctured. However, because leakage is often very slow, you should look closely for punctures whenever a tyre is not fully inflated.

Always check air pressure when your tyres are "cold" — when the motorcycle has been parked for at least three hours. If you check air pressure when your tyres are "warm" — when the motorcycle has been ridden for even a few miles — the readings will be higher than if the tyres were "cold". This is normal, so do not let air out of the tyres to match the recommended cold air pressures given below. If you do, the tyres will be underinflated.

The recommended "cold" tyre pressures are:

kPa (kgf/cm <sup>2</sup> , psi)		
Driver only	Front	200 (2.00, 29)
	Rear	225 (2.25, 33)
Driver and one passenger	Front	200 (2.00, 29)
	Rear	225 (2.25, 33)

### Inspection

Whenever you check the tyre pressures, you should also examine the tyre treads and sidewalls for wear, damage, and foreign objects:

#### Look for:

- Bumps or bulges in the side of the tyre or the tread. Replace the tyre if you find any bumps or bulges.
- Cuts, splits or cracks in the tyre. Replace the tyre if you can see fabric or cord.
- Excessive tread wear.

Also, if you hit a pothole or hard object, pull to the side of the road as soon as you safely can and carefully inspect the tyre for damage.

### Tread Wear

Replace tyres before tread depth at the center of the tyre reaches the following limit:

Minimum tread depth	
Front:	1.5 mm (0.06 in)
Rear:	2.0 mm (0.08 in)

#### <For Germany>

German law prohibits use of tyres whose tread depth is less than 1.6 mm.

Follow all instructions in this owner's manual regarding tyre inflation and maintenance.

Replace tyres before tread depth at the center of the tyre reaches the following limit:



- (1) Wear indicator
- (2) Wear indicator location mark

### Tyre Repair

If a tyre is punctured or damaged, you should replace it, not repair it. As discussed below, a tyre that is repaired, either temporarily or permanently, will have lower speed and performance limits than a new tyre.

A temporary repair, such as an external tubeless tyre plug, may not be safe for normal speeds and riding conditions. If a temporary or emergency repair is made to a tyre, you should ride slowly and cautiously to a dealer and have the tyre replaced. If possible, you should not carry a passenger or cargo until a new tyre is installed.

Even if a tyre is professionally repaired with a permanent internal patch plug, it will not be as good as a new tyre. You should not exceed 80 km/h (50 mph) for the first 24 hours, or 120 km/h (75 mph) at any time thereafter. In addition, you may not be able to safely carry as much weight as with a new tyre. Therefore, we strongly recommend that you replace a damaged tyre. If you choose to have a tyre repaired, be sure the wheel is balanced before you ride.

Follow all instructions in this owner's manual regarding tyre inflation and maintenance.

### Tyre Replacement

The tyres that came on your motorcycle were designed to match the performance capabilities of your motorcycle and provide the best combination of handling, braking, durability and comfort.

### ⚠ WARNING

Installing improper tyres on your motorcycle can affect handling and stability. This can cause a crash in which you can be seriously hurt or killed.

Always use the size and type of tyres recommended in this owner's manual.

The recommended tyres for your motorcycle are:

Front: 80/90-17M/C 44P  
IRC  
NR73s

Rear: 100/80-17M/C 52P  
IRC  
NR73s

Whenever you replace a tyre, use one that is equivalent to the original and be sure the wheel is balanced after the new tyre is installed.

### Important Safety Reminders

- Do not install a tube inside a tubeless tyre on this motorcycle. Excessive heat build-up can cause the tube to burst.
- Use only tubeless tyres on this motorcycle. The rims are designed for tubeless tyres, and during hard acceleration or braking, a tube-type tyre could slip on the rim and cause the tyre to rapidly deflate.



## ESSENTIAL INDIVIDUAL COMPONENTS

### IGNITION SWITCH

The ignition switch (1) is below the indicator panel.

The headlights and taillight will come on whenever you turn the ignition switch ON. If your motorcycle is stopped with the ignition switch ON and the engine is not running, the headlights and taillight will still be on, resulting in battery discharge.

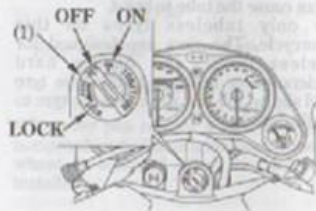

(1) Ignition switch

Key Position	Function	Key Removal
LOCK (steering lock)	Steering is locked. Engine and lights cannot be operated.	Key can be removed.
OFF	Engine and lights cannot be operated.	Key can be removed.
ON	Engine and lights can be operated.	Key cannot be removed.

### KEYS (LAND/SEA CONTROLS)

This motorcycle has two keys and a key number plate.

You will need the key number if you ever have to replace a key. Store the plate in a safe place.

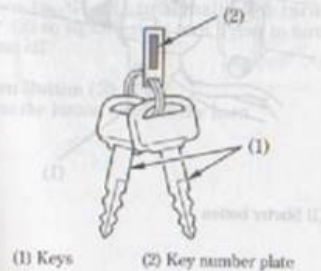

(1) Keys (2) Key number plate

To reproduce keys, bring all keys, key number plate and motorcycle to your Honda dealer.

- (1) Headlight dimmer switch
- (2) Turn signal switch
- (3) Horn button

## RIGHT HANDLEBAR CONTROLS

### Starter Button (1)

The starter button (1) is next to the throttle grip.

When the starter button is pressed, the starter motor cranks the engine. See page 46 for the starting procedure.

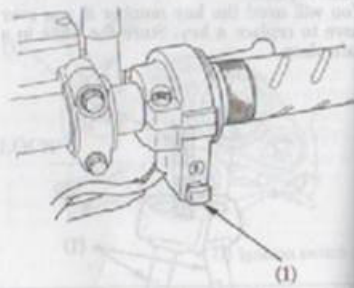

(1) Starter button

Key Position	Function	Engine
LOCK (steering lock)	Steering is locked. Engine cannot be operated.	Engine cannot be operated.
OFF	Engine and lights cannot be operated. Key cannot be removed.	Engine cannot be operated.
ON	Engine and lights can be operated.	Engine can be operated.

## LEFT HANDLEBAR CONTROLS

### Headlight Dimmer Switch (1)

Push the headlight dimmer switch to to select high beam or to to select low beam.

### Turn Signal Switch (2)

Move to (L) to signal a left turn, (R) to signal a right turn. Press to turn signal off.

### Horn Button (3)

Press the button to sound the horn.

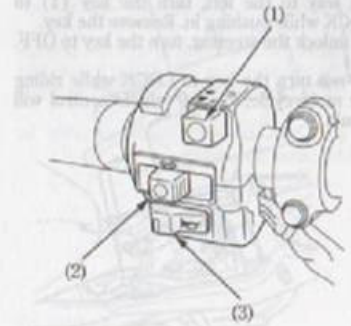

(1) Headlight dimmer switch  
(2) Turn signal switch  
(3) Horn button

## FEATURES

### (Not required for operation)

#### STEERING LOCK

To lock the steering, turn the handlebar all the way to the left, turn the key (1) to LOCK while pushing in. Remove the key. To unlock the steering, turn the key to OFF.

Do not turn the key to LOCK while riding the motorcycle; loss of vehicle control will result.

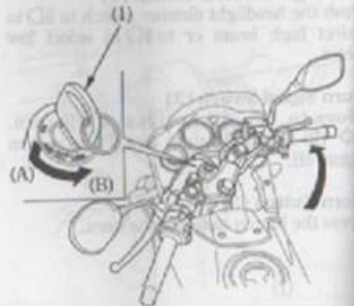

(1) Ignition key

(A) Push in  
(B) Turn to LOCK

## SEAT

### Front seat

To remove the front seat (1), remove the rear seat (page 38) and bolt (2), and then pull the seat back and up.

To install the front seat, insert the tab (3) into the recess under the frame and tighten the bolts securely. Install the rear seat.

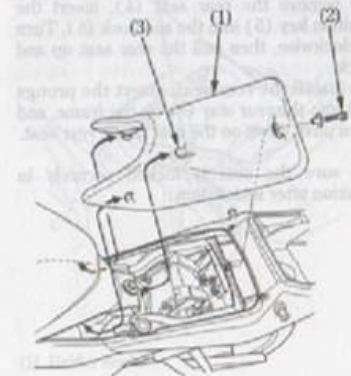

(1) Front seat  
(2) Bolt

(3) Tab

## FEATURES

(Required for operation)

### Rear seat

To remove the rear seat (4), insert the ignition key (5) into the seat lock (6). Turn it clockwise, then pull the rear seat up and back.

To install the rear seat, insert the prongs (7) into the rear stay (8) on the frame, and then push down on the rear of the rear seat.

Be sure the seat is locked securely in position after installation.

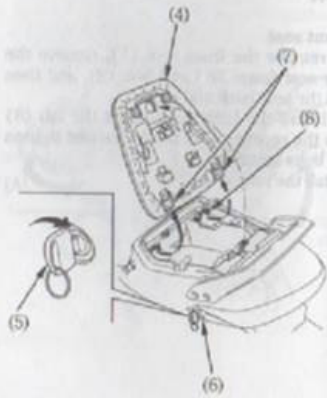

- (4) Rear seat
- (5) Ignition key
- (6) Seat lock
- (7) Prongs
- (8) Rear stay

## HELMET HOLDER

The helmet holders are located below the rear seat.

Remove the rear seat (page 38). Hang the helmets on the holder hooks (1). Install the rear seat and lock it securely.

### ⚠ WARNING

Riding with a helmet attached to the holder can interfere with the rear wheel or suspension and could cause a crash in which you can be seriously hurt or killed.

Use the helmet holder only while parked. Do not ride with a helmet secured by the holder.

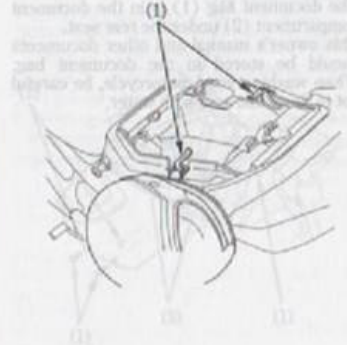

- (1) Holder hooks

- (1) Bolts
- (2) Hooks
- (3) Grommets

## DOCUMENT BAG

The document bag (1) is in the document compartment (2) under the rear seat.

This owner's manual and other documents should be stored in the document bag. When washing your motorcycle, be careful not to flood this area with water.

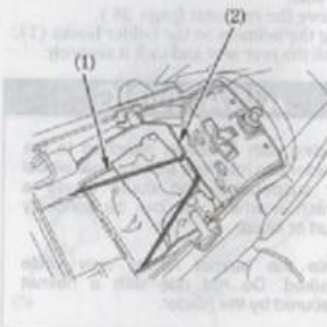

- (1) Document bag
- (2) Document compartment

## OPERATION

### MIDDLE COWL

#### Removal:

1. Remove the bolts (1).
2. Remove the hooks (2) from the grommets (3).

#### Installation:

- Installation can be done in the reverse order of removal.

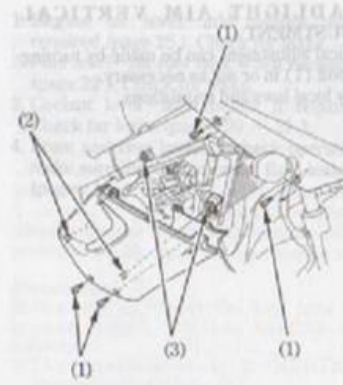

- (1) Bolts
- (2) Hooks
- (3) Grommets

## HEADLIGHT AIM VERTICAL ADJUSTMENT

Vertical adjustment can be made by turning the bolt (1) in or out as necessary. Obey local laws and regulations.

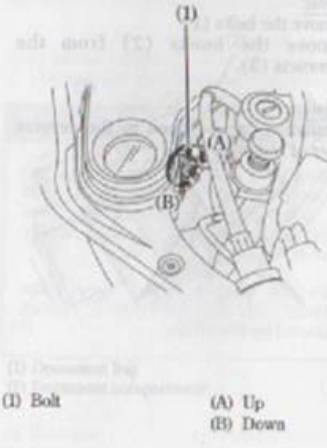

## OPERATION

### PRE-RIDE INSPECTION

For your safety, it is very important to take a few moments before each ride to walk around your motorcycle and check its condition. If you detect any problem, be sure you take care of it, or have it corrected by your Honda dealer.

### ⚠ WARNING

Improperly maintaining this motorcycle or failing to correct a problem before riding can cause a crash in which you can be seriously hurt or killed.

Always perform a pre-ride inspection before every ride and correct any problems.

1. Engine oil level—add engine oil if required (page 25). Check for leaks.
2. Fuel level—fill fuel tank when necessary (page 22). Check for leaks.
3. Coolant level—add coolant if required. Check for leaks (pages 20 – 21).
4. Front and rear brakes—check operation; make sure there is no brake fluid leakage (pages 16 – 17).

**Preparation**  
Before starting, insert the key into the ignition switch ON and confirm the following:  
• The transmission is in NEUTRAL (neutral indicator light ON).

5. Tyres—check condition and pressure (pages 26 – 31).
6. Drive chain—check condition and slack (page 74). Adjust and lubricate if necessary.
7. Throttle—check for smooth opening and full closing in all steering positions.
8. Lights and horn—check that headlight, tail/brake light, turn signals, indicators and horn function properly.
9. Side stand ignition cut-off system—check for proper function (page 81).

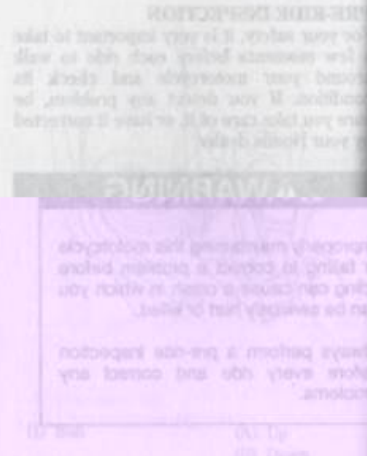

### STARTING THE ENGINE

Always follow the proper starting procedure described below.

This motorcycle is equipped with a side stand ignition cut-off system. The engine cannot be started if the side stand is down, unless the transmission is in neutral. If the side stand is up, the engine can be started in neutral or in gear with the clutch lever

pulled in. After starting with the side stand down, the engine will shut off if the transmission is put in gear before raising the side stand.

To protect the catalytic converter in your motorcycle's exhaust system, avoid extending idling and the use of leaded petrol.

Your motorcycle's exhaust contains poisonous carbon monoxide gas. High levels of carbon monoxide can collect rapidly in enclosed areas such as a garage. Do not run the engine with the garage door closed. Even with the door open, run the engine only long enough to move your motorcycle out of the garage.

Do not use the electric starter for more than 5 seconds at a time. Release the starter button for approximately 10 seconds before pressing it again.

#### Preparation

Before starting, insert the key, turn the ignition switch ON and confirm the following:

- The transmission is in NEUTRAL (neutral indicator light ON).



### Starting Procedure

To restart a warm engine, follow the procedure for "High Air Temperature".

### Normal Air Temperature

10°–35°C (50°–95°F)

1. Pull the choke knob (1) up all the way to Fully ON (A), if the engine is cold.
2. With the throttle closed, press the starter button.

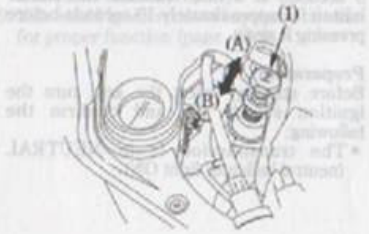

(1) Choke knob (A) Fully ON (B) Fully OFF

3. Immediately after the engine starts, operate the choke knob (1) to keep fast idle at:  
2,000–3,000 min<sup>-1</sup> (rpm)
4. About a half minute after the engine starts, push the choke knob down all the way to Fully OFF (B).
5. If idling is unstable, open the throttle slightly.

### High Air Temperature

35°C (95°F) or above

1. Do not use the choke.
2. With the throttle slightly open, press the starter button.

### Low Air Temperature

10°C (50°F) or below

1. Follow steps 1–2 under "Normal Air Temperature."
2. When engine speed begins to pick up, operate the choke knob to keep fast idle at:  
2,000–3,000 min<sup>-1</sup> (rpm)
3. Continue warming up the engine until it runs smoothly and responds to the throttle, when the choke knob (1) is at Fully OFF (B).

### NOTICE

Extended use of the choke may impair piston and cylinder wall lubrication and damage the engine.

### Flooded Engine

If the engine fails to start after repeated attempts, it may be flooded with excess fuel. To clear a flooded engine, turn the ignition switch to ON, and move the choke knob to Fully OFF (B). Open the throttle fully and crank the engine for 5 seconds. If the engine starts, quickly close the throttle, then open it slightly if idling is unstable. If the engine does not start, wait 10 seconds, then follow the Starting Procedure.



### RUNNING-IN

Help assure your motorcycle's future reliability and performance by paying extra attention to how you ride during the first 500 km (300 miles). During this period, avoid full-throttle starts and rapid acceleration.

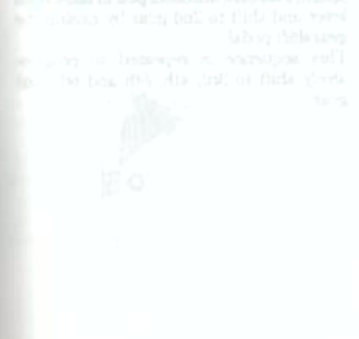

## RIDING

Review Motorcycle Safety (pages 1 - 7) before you ride.

Make sure you understand the function of the side stand mechanism. (See MAINTENANCE SCHEDULE on page 60 and explanation for SIDE STAND on page 81).

Make sure flammable materials such as dry grass or leaves do not come in contact with the exhaust system when riding, idling, or parking your motorcycle.

1. After the engine has been warmed up, the motorcycle is ready for riding.
2. While the engine is idling, pull in the clutch lever and depress the gearshift pedal to shift into 1st (low) gear.

3. Slowly release the clutch lever and at the same time gradually increase engine speed by opening the throttle. Coordination of the throttle and clutch lever will assure a smooth positive start.
4. When the motorcycle attains a moderate speed, close the throttle, pull in the clutch lever and shift to 2nd gear by raising the gearshift pedal. This sequence is repeated to progressively shift to 3rd, 4th, 5th and 6th (top) gear.

5. Coordinate the throttle and brakes for smooth deceleration.
6. Both front and rear brakes should be used at the same time and should not be applied strongly enough to lock the wheel, or braking effectiveness will be reduced and control of the motorcycle be difficult.

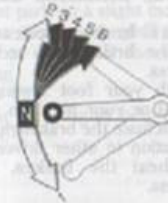

## BRAKING

For normal braking, apply both the brake pedal and lever while down-shifting to match your road speed. For maximum braking, close the throttle and firmly apply the pedal and lever; pull in the clutch lever before coming to a complete stop to prevent stalling the engine.

### Important Safety Reminders:

- Independent operation of only the brake lever or brake pedal reduces stopping performance.
- Extreme application of the brake controls may cause wheel lock, reducing control of the motorcycle.
- When possible, reduce speed or brake before entering a turn; closing the throttle or braking in mid-turn may cause wheel slip. Wheel slip will reduce control of the motorcycle.

- When riding in wet or rainy conditions, or on loose surfaces, the ability to maneuver and stop will be reduced. All of your actions should be smooth under these conditions. Rapid acceleration, braking or turning may cause loss of control. For your safety, exercise extreme caution when braking, accelerating or turning.
- When descending a long, steep grade, use engine compression braking by down-shifting, with intermittent use of both brakes. Continuous brake application can overheat the brakes and reduce their effectiveness.
- Do not rest your foot on the brake pedal or your hand on the brake lever. This may actuate the brakelight, giving a false indication to other drivers. It may also overheat the brakes, reducing effectiveness.

## MAINTENANCE

### PARKING

1. After stopping the motorcycle, shift the transmission into neutral, turn the handlebar fully to the left, turn the ignition switch OFF and remove the key.
2. Use the side stand to support the motorcycle while parked.

Park the motorcycle on firm, level ground to prevent it from falling over.

If you must park on a slight incline, aim the front of the motorcycle uphill to reduce the possibility of rolling off the side stand or overturning.

3. Lock the steering to help prevent theft (page 36).

Make sure flammable materials such as dry grass or leaves do not come in contact with the exhaust system when parking your motorcycle.

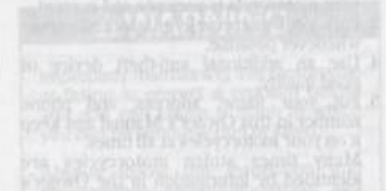

### ANTI-THEFT TIPS

1. Always lock the steering and never leave the key in the ignition switch. This sounds simple but people do forget.
2. Be sure the registration information for your motorcycle is accurate and current.
3. Park your motorcycle in a locked garage whenever possible.
4. Use an additional anti-theft device of good quality.
5. Put your name, address, and phone number in this Owner's Manual and keep it on your motorcycles at all times. Many times stolen motorcycles are identified by information in the Owner's Manuals that are still with them.

NAME: \_\_\_\_\_

ADDRESS: \_\_\_\_\_  
\_\_\_\_\_  
\_\_\_\_\_

PHONE NO: \_\_\_\_\_

## MAINTENANCE

### THE IMPORTANCE OF MAINTENANCE

A well-maintained motorcycle is essential for safe, economical and trouble-free riding. It will also help reduce air pollution.

To help you properly care for your motorcycle, the following pages include a Maintenance Schedule and a Maintenance Record for regularly scheduled maintenance.

These instructions are based on the assumption that the motorcycle will be used exclusively for its designed purpose. Sustained high speed operation or operation in unusually wet or dusty conditions will require more frequent service than specified in the Maintenance Schedule. Consult your Honda dealer for recommendations applicable to your individual needs and use.

If your motorcycle overturns or becomes involved in a crash, be sure your Honda dealer inspects all major parts, even if you are able to make some repairs.

### ⚠ WARNING

Improperly maintaining this motorcycle or failing to correct a problem before you ride can cause a crash in which you can be seriously hurt or killed.

Always follow the inspection and maintenance recommendations and schedules in this owner's manual.

### MAINTENANCE SAFETY

This section includes instructions on some important maintenance tasks. You can perform some of these tasks with the tools provided — if you have basic mechanical skills.

Other tasks that are more difficult and require special tools are best performed by professionals. Wheel removal should normally be handled only by a Honda technician or other qualified mechanic; instructions are included in this manual only to assist in emergency service.

Some of the most important safety precautions follow. However, we cannot warn you of every conceivable hazard that can arise in performing maintenance. Only you can decide whether or not you should perform a given task.

### ⚠ WARNING

Failure to properly follow maintenance instructions and precautions can cause you to be seriously hurt or killed.

Always follow the procedures and precautions in this owner's manual.

### SAFETY PRECAUTIONS

- **Make sure the engine is off before you begin any maintenance or repairs.** This will help eliminate several potential hazards:
  - **Carbon monoxide poisoning from engine exhaust.** Be sure there is adequate ventilation whenever you operate the engine.
  - **Burns from hot parts.** Let the engine and exhaust system cool before touching.
  - **Injury from moving parts.** Do not run the engine unless instructed to do so.
- **Read the instructions before you begin, and make sure you have the tools and skills required.**
- **To help prevent the motorcycle from falling over, park it on a firm, level surface, using the side stand or a maintenance stand to provide support.**

- **To reduce the possibility of a fire or explosion, be careful when working around petrol or batteries.** Use only nonflammable solvent, not petrol, to clean parts. Keep cigarettes, sparks and flames away from the battery and all fuel-related parts.

Remember that your Honda dealer knows your motorcycle best and is fully equipped to maintain and repair it.

To ensure the best quality and reliability, use only new genuine Honda parts or their equivalents for repair and replacement.

## MAINTENANCE SCHEDULE

Perform the Pre-ride Inspection (page 43) at each scheduled maintenance period.

I: INSPECT AND CLEAN, ADJUST, LUBRICATE OR REPLACE IF NECESSARY

C: CLEAN R: REPLACE A: ADJUST L: LUBRICATE

The following items require some mechanical knowledge. Certain items (particularly those marked \* and \*\*) may require more technical information and tools. Consult your Honda dealer.

- \* Should be serviced by your Honda dealer, unless the owner has proper tools and service data and is mechanically qualified. Refer to the Official Honda Shop Manual.
- \*\* In the interest of safety, we recommend these items be serviced only by your Honda dealer.

Honda recommends that your Honda dealer should road test your motorcycle after each periodic maintenance is carried out.

NOTES: (1) At higher odometer readings, repeat at the frequency interval established here.

(2) Service more frequently if the motorcycle is ridden in unusually wet or dusty areas.

(3) Service more frequently when riding in rain or at full throttle.

(4) Replace every 2 years. Replacement requires mechanical skill.

(5) Replace every 3 years or 24,000 km (15,000 mile). Replacement requires mechanical skill.

ITEM	FREQUENCY	WHICHEVER → COMES FIRST	ODOMETER READING [NOTE (1)]				REFER TO PAGE
			× 1,000 km	4	8	12	
			× 1,000 mi	0.6	2.5	5	
	NOTE	MONTH	6	12	18		
* FUEL LINE				I	I	I	—
* THROTTLE OPERATION				I	I	I	—
* CHOKE OPERATION				I	I	I	—
** AIR CLEANER		NOTE (2)		C	C	R	—
CRANKCASE BREATHER		NOTE (3)		C	C	C	64
SPARK PLUG				I	R	I	68
* VALVE CLEARANCE			I	I	I	I	—
ENGINE OIL			R		R		65
** ENGINE OIL STRAINER SCREEN						C	—
* ENGINE IDLE SPEED			I	I	I	I	72
RADIATOR COOLANT		NOTE (4)			I		20
* COOLING SYSTEM					I		—
* SECONDARY AIR SUPPLY SYSTEM		NOTE (5)				I	—

### MAINTENANCE SCHEDULE

ITEM	FREQUENCY	WHICHEVER COMES FIRST	ODOMETER READING [ NOTE (1) ]				REFER TO PAGE
			× 1,000 km	4	8	12	
			× 1,000 mi	0.6	2.5	5	
		NOTE	MONTH	6	12	18	
DRIVE CHAIN				EVERY 1,000km (600mi) 1			74
BRAKE FLUID		NOTE (4)		1	1	1	16
BRAKE PAD WEAR				1	1	1	86
BRAKE SYSTEM				1	1	1	16, 86
* BRAKE LIGHT SWITCH				1	1	1	93
* HEADLIGHT AIM				1	1	1	42
CLUTCH SYSTEM				1	1	1	16
SIDE STAND				1	1	1	61
* SUSPENSION				1	1	1	80
* NUTS, BOLTS, FASTENERS				1	1	1	—
** WHEELS/TYRES				1	1	1	—
* FLYWHEEL/JAVASU/ARMINGS				1	1	1	—

### TOOL KIT

The tool kit (1) is in the tool box under the rear seat (page 38 ).

Some roadside repairs, minor adjustments and parts replacement can be performed with the tools contained in the kit.

- \* Spark plug wrench
- \* 19 mm Box end wrench
- \* 10 × 12 mm Open end wrench
- \* 14 × 17 mm Open end wrench
- \* 5 mm Hex wrench
- \* No. 2 phillips screwdriver
- \* No. 2 screwdriver
- \* Screwdriver handle
- \* Pliers
- \* Extension bar
- \* Tool bag

RECORD THE MILEAGE FOR YOUR INTERVAL

The front and rear wheel numbers are recorded when registering your motorcycle. They may also be required by the dealer when ordering replacement parts. Record the mileage for your intervals.



(1) Tool kit

### SERIAL NUMBERS

The frame and engine serial numbers are required when registering your motorcycle. They may also be required by your dealer when ordering replacement parts. Record the numbers here for your reference.

FRAME NO. \_\_\_\_\_

The frame number (1) is stamped on the right side of the steering head.

The engine number (2) is stamped on the left side of the crankcase.

ENGINE NO. \_\_\_\_\_

### COLOUR LABEL

The colour label (1) is attached to the left side of the frame.

It is helpful when ordering replacement parts. Record the colour and code here for your reference.

COLOUR \_\_\_\_\_

CODE \_\_\_\_\_

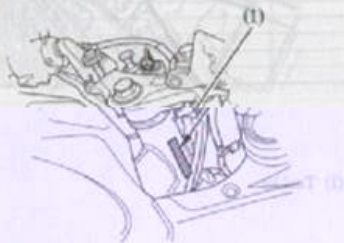

(1) Frame number  
62

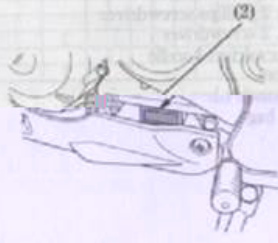

(2) Engine number

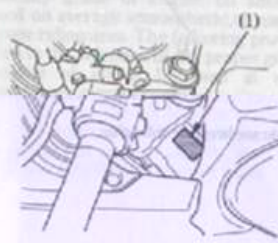

(1) Colour label

### CRANKCASE BREATHER

Refer to the Safety Precautions on page 57.

1. Remove the crankcase breather tube plug (1) from the tube and drain deposits into a suitable container.
2. Reinstall the crankcase breather tube plug.

Service more frequently when ridden in rain, at full throttle, or after the motorcycle is washed or overturned. Service if the deposit level can be seen in the transparent section of the crankcase breather tube.

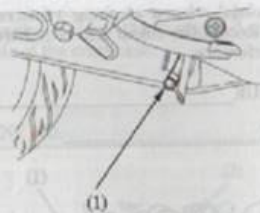

(1) Crankcase breather tube plug

### ENGINE OIL

Refer to the Safety Precautions on page 57.

#### Engine Oil

Good engine oil has many desirable qualities. Use only high detergent, quality motor oil certified on the container to meet or exceed requirements for API Service Classification SE, SF or SG.

#### Viscosity:

Viscosity grade of engine oil should be based on average atmospheric temperature in your riding area. The following provides a guide to the selection of the proper grade or viscosity of oil to be used at various atmospheric temperatures.

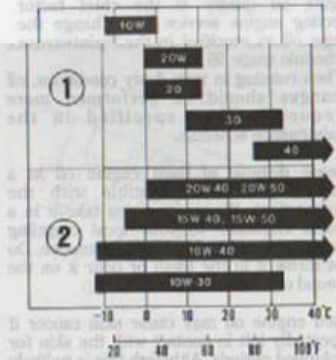

(1) Single grade (2) Multi grade

**Engine Oil**  
 Engine oil quality is the chief factor affecting engine service life. Change the engine oil as specified in the maintenance schedule (page 59).

When running in very dusty conditions, oil changes should be performed more frequently than specified in the maintenance schedule.

Please dispose of used engine oil in a manner that is compatible with the environment. We suggest you take it in a sealed container to your local recycling center or service station for reclamation. Do not throw it in the trash or pour it on the ground or down a drain.

Used engine oil may cause skin cancer if repeatedly left in contact with the skin for prolonged periods. Although this is unlikely unless you handle used oil on a daily basis, it is still advisable to thoroughly wash your hands with soap and water as soon as possible after handling used oil.

Changing the oil requires a torque wrench. If you do not have it and the necessary skill, we recommend that you have your Honda dealer perform this service.

If a torque wrench is not used for this installation, see your Honda dealer as soon as possible to verify proper assembly.

Change the engine oil with the engine at normal operating temperature and the motorcycle on its side stand to assure complete and rapid draining.

Change the engine oil with the engine at normal operating temperature and the motorcycle on its side stand to assure complete and rapid draining.

(1) Crankcase breather tube plug

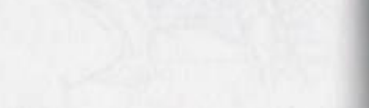

1. To drain the oil, remove the oil filler cap/dipstick and oil drain plug (1) and sealing washer (2).

2. Check that the sealing washer on the drain plug is in good condition and install the plug. Replace the sealing washer every other time the oil is changed, or each time if necessary.

Oil Drain Plug Torque:  
 25 N·m (2.5 kgf·m, 18 lbf·ft)

3. Fill the crankcase with the recommended grade oil, approximately:

1.0 L (1.1 US qt, 0.9 Imp qt)

4. Install the oil filler cap/dipstick.  
 5. Start the engine and let it idle for 3–5 minutes.

6. 2–3 minutes after stopping the engine, check that the oil level is at the upper level mark on the dipstick with the motorcycle upright on firm, level ground. Make sure there are no oil leaks.

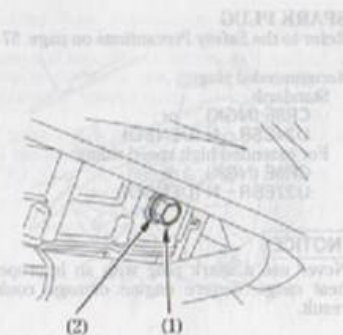

(1) Oil drain plug (2) Sealing washer

**SPARK PLUG**

Refer to the Safety Precautions on page 57.

Recommended plug:

Standard:  
 CR8E (NGK) or  
 U24ESR-N (DENSO)

For extended high speed riding:  
 CR9E (NGK) or  
 U27ESR-N (DENSO)

**NOTICE**

Never use a spark plug with an improper heat range. Severe engine damage could result.

Used engine oil may cause skin cancer if repeatedly left in contact with the skin for prolonged periods. Although this is unlikely unless you handle used oil on a daily basis, it is still advisable to thoroughly wash your hands with soap and water as soon as possible after handling used oil.

Change the oil with the engine at normal operating temperature and the motorcycle on its side stand to assure complete and rapid draining.

Change the oil with the engine at normal operating temperature and the motorcycle on its side stand to assure complete and rapid draining.

Change the oil with the engine at normal operating temperature and the motorcycle on its side stand to assure complete and rapid draining.

Change the oil with the engine at normal operating temperature and the motorcycle on its side stand to assure complete and rapid draining.

Change the oil with the engine at normal operating temperature and the motorcycle on its side stand to assure complete and rapid draining.

Change the oil with the engine at normal operating temperature and the motorcycle on its side stand to assure complete and rapid draining.

1. Remove the middle cowl (page 41).  
 2. Disconnect the spark plug cap (1) from the spark plug.

3. Clean any dirt from around the spark plug bases. Remove the spark plug using the spark plug wrench (2) furnished in the tool kit.

Change the oil with the engine at normal operating temperature and the motorcycle on its side stand to assure complete and rapid draining.

Change the oil with the engine at normal operating temperature and the motorcycle on its side stand to assure complete and rapid draining.

Change the oil with the engine at normal operating temperature and the motorcycle on its side stand to assure complete and rapid draining.

Change the oil with the engine at normal operating temperature and the motorcycle on its side stand to assure complete and rapid draining.

Change the oil with the engine at normal operating temperature and the motorcycle on its side stand to assure complete and rapid draining.



(1) Spark plug cap  
 (2) Spark plug wrench

(1) Lock nut (2) Adjuster

- Inspect the electrodes and center porcelain for deposits, erosion or carbon fouling. If the erosion or deposit is heavy, replace the plug. Clean a carbon or wet-fouled plug with a plug cleaner, otherwise use a wire brush.
- Check the spark plug gap (3) using a wire-type feeler gauge. If adjustment is necessary, bend the side electrode (4) carefully.  
The gap should be:  
0.70–0.80 mm (0.028–0.031 in)

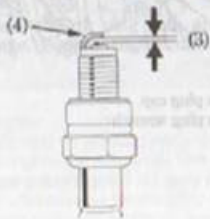

(3) Spark plug gap (4) Side electrode

- With the plug washer attached, thread the spark plug in by hand to prevent cross-threading.
- Tighten the spark plug 1/2 turn with a spark plug wrench to compress the washer.

**NOTICE**

The spark plug must be securely tightened. An improperly tightened plug can become very hot and possibly damage the engine.

- Reinstall the spark plug cap.
- Install the remaining parts in the reverse order of removal.

**THROTTLE OPERATION**

Refer to the Safety Precautions on page 57.

- Check for smooth rotation of the throttle grip from the fully open to the fully closed position at both full steering positions.
- Measure the throttle grip free play at the throttle grip flange.  
The standard free play should be approximately:  
2–6 mm (0.1–0.2 in)

To adjust the free play, loosen the lock nut (1) and turn the adjuster (2).

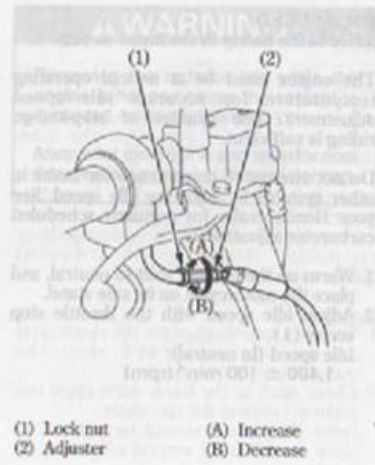

(1) Lock nut (2) Adjuster (A) Increase (B) Decrease

**IDLE SPEED**

Refer to the Safety Precautions on page 57.

The engine must be at normal operating temperature for accurate idle speed adjustment. Ten minutes of stop-and-go riding is sufficient.

Do not attempt to compensate for faults in other systems by adjusting idle speed. See your Honda dealer for regularly scheduled carburetor adjustments.

- Warm up the engine, shift to neutral, and place the motorcycle on its side stand.
- Adjust idle speed with the throttle stop screw (1).  
Idle speed (In neutral):  
1,400 ± 100 min<sup>-1</sup> (rpm)



(1) Throttle stop screw (A) Increase (B) Decrease

(3) Spark plug gap (4) Side electrode

**COOLANT**

Refer to the Safety Precautions on page 57.

**Coolant Replacement**

Coolant should be replaced by a Honda dealer, unless the owner has proper tools and service data and is mechanically qualified. Refer to an official Honda Shop Manual.

Always add coolant to the reserve tank. Do not attempt to add coolant by removing the radiator cap.

**⚠ WARNING**

Removing the radiator cap while the engine is hot can cause the coolant to spray out, seriously scalding you.

Always let the engine and radiator cool down before removing the radiator cap.

## DRIVE CHAIN

Refer to the Safety Precautions on page 57.

The service life of the drive chain is dependent upon proper lubrication and adjustment. Poor maintenance can cause premature wear or damage to the drive chain and sprockets.

The drive chain should be checked and lubricated as part of the Pre-ride Inspection (page 43). Under severe usage, or when the motorcycle is ridden in unusually dusty or muddy areas, more frequent maintenance will be necessary.

### Inspection:

1. Turn the engine off, place the motorcycle on its side stand and shift the transmission into neutral. Check slack in the lower drive chain run midway between the sprockets. Drive chain slack should be adjusted to the following vertical movement by and:

25 - 35 mm (1.0 - 1.4 in)

3. Roll the motorcycle forward. Stop. Check the drive chain slack. Repeat this procedure several times. Drive chain slack should remain constant. If the chain is slack only in certain sections, some links are kinked and binding. Binding and kinking can frequently be eliminated by lubrication.

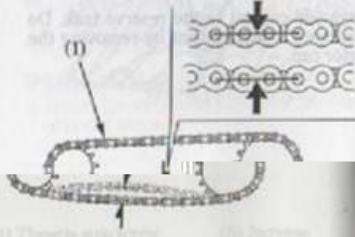

(1) Drive chain

4. Roll the motorcycle forward. Stop and place it on its side stand. Inspect the drive chain and sprockets for any of the following conditions:

### DRIVE CHAIN

- \* Damaged Rollers
- \* Loose Pins
- \* Dry or Rusted Links
- \* Kinked or Binding Links
- \* Excessive Wear
- \* Improper Adjustment
- \* Damaged or Missing O-rings

### SPROCKETS

- \* Excessively Worn Teeth
- \* Broken or Damaged Teeth

A drive chain with damaged rollers, loose pins, or missing O-rings must be replaced. A chain which appears dry, or shows signs of rust, requires supplementary lubrication. Kinked or binding links should be thoroughly lubricated and worked free. If links cannot be freed, the chain must be replaced.

Damaged sprocket  
Teeth

Replace

Worn sprocket  
Teeth

Replace



Normal sprocket Teeth

GOOD

### Adjustment:

Drive chain slack should be checked and adjusted, if necessary, every 1,000 km (600 miles). When operated at sustained high speeds or under conditions of frequent rapid acceleration, the chain may require more frequent adjustment.

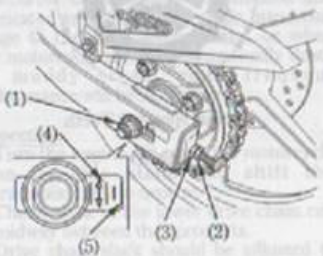

- (1) Axle nut
- (2) Lock nuts
- (3) Adjusting nut
- (4) Index mark
- (5) Rear edge of adjusting slot

76

If the drive chain requires adjustment, the procedure is as follows:

1. Place the motorcycle on its side stand with the transmission in neutral and the ignition switch off.
2. Loosen the axle nut (1).
3. Loosen the lock nuts (2) on both right and left swingarm.
4. Turn both adjusting nuts (3) an equal number of turns until the correct drive chain slack is obtained. Turn the adjusting nuts clockwise to tighten the chain, or counterclockwise to provide more slack. Adjust the chain slack at a point midway between the drive sprocket and the rear wheel sprocket. Rotate the rear wheel and recheck slack at other sections of the chain. Chain slack should be: 25 - 35 mm (1.0 - 1.4 in)

(1) Drive chain

5. Check rear axle alignment by making sure the chain adjuster index marks (4) align with the rear edge (5) of the adjusting slots.

Both left and right marks should correspond. If the axle is misaligned, turn the left or right adjusting nut until the marks correspond on the rear edge of the adjusting slots and recheck chain slack.

6. Tighten the axle nut to specified torque.

Axle nut torque:

59 N·m (6.0 kgf·m, 43 lbf·ft)

If a torque wrench is not used for this installation, see your Honda dealer as soon as possible to verify proper assembly.

7. Tighten the adjusting nuts lightly, then tighten the lock nuts by holding the adjusting nuts with a spanner.

(1) Drive chain

(2) Drive chain

(3) Drive chain

(4) Drive chain

(5) Drive chain

(6) Drive chain

(7) Drive chain

(8) Drive chain

(9) Drive chain

(10) Drive chain

(11) Drive chain

(12) Drive chain

(13) Drive chain

(14) Drive chain

(15) Drive chain

(16) Drive chain

(17) Drive chain

(18) Drive chain

(19) Drive chain

(20) Drive chain

(21) Drive chain

(22) Drive chain

(23) Drive chain

(24) Drive chain

(25) Drive chain

(26) Drive chain

(27) Drive chain

(28) Drive chain

(29) Drive chain

(30) Drive chain

(31) Drive chain

(32) Drive chain

(33) Drive chain

(34) Drive chain

### Wear Inspection:

Check the chain wear label when adjusting the chain. If the red zone (6) on the label aligns with the arrow mark (7) on the chain adjuster plates after the chain has been adjusted to the proper slack, the chain is excessively worn and must be replaced. The proper slack is:

25 - 35 mm (1.0 - 1.4 in)

Damage to the bottom part of the frame may be caused by excessive drive chain slack of more than:

50 mm (2.0 in)

Replacement chain:  
D.I.D. 428V13-124LE

This motorcycle has a staked master link drive chain which requires a special tool for cutting and staking. Do not use an ordinary master link with this chain. See your Honda dealer.

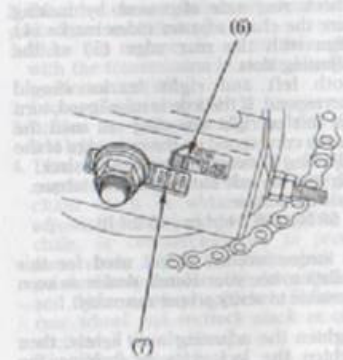

(6) Red zone

(7) Arrow mark

### Lubrication and Cleaning:

Lubricate every 1,000 km (600 miles) or sooner if chain appears dry.

The drive chain on this motorcycle is equipped with small O-rings between the link plates. These O-rings retain grease inside the chain to improve its service life. The O-rings in this chain can be damaged by steam cleaning, high pressure washers, and certain solvents. Clean the side surfaces of the chain with a dry cloth. Do not brush the rubber O-rings. Brushing will damage them. Wipe dry and lubricate only with SAE 80 or 90 gear oil. Commercial chain lubricants may contain solvents which could damage the rubber O-rings.



### FRONT AND REAR SUSPENSION INSPECTION

Refer to the Safety Precautions on page 57.

1. Check the front fork assembly by locking the front brake and pumping the fork up and down vigorously. Suspension action should be smooth.
2. Rear fork bushing - this can be checked by pushing hard against the side of the rear wheel while the motorcycle is on a support block. Feeling for looseness of the fork bushings.
3. Carefully inspect all front and rear suspension fasteners for tightness.

This motorcycle has a staked master link drive chain which requires a special tool for cutting and staking. Do not use an ordinary master link with this chain. See your Honda dealer.

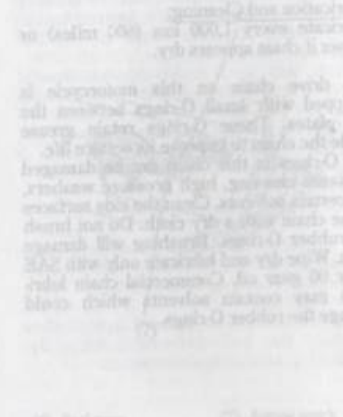

(6) Red zone

(7) Arrow mark

### SIDE STAND

Refer to the Safety Precautions on page 57.

Perform the following maintenance in accordance with the maintenance schedule.

#### Functional Check:

- Check the spring (1) for damage or loss of tension and the side stand assembly for freedom of movement.
- Check the side stand ignition cut-off system:
  1. Sit astride the motorcycle; put the side stand up and the transmission in neutral.
  2. Start the engine and with the clutch lever pulled in, shift the transmission into gear.
  3. Lower the side stand. The engine should stop as you put the side stand down.

If the side stand system does not operate as described, see your Honda dealer for service.

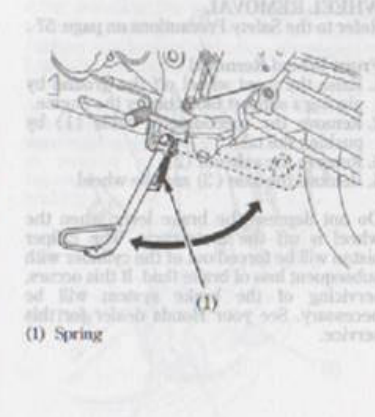

(1) Spring

## WHEEL REMOVAL

Refer to the Safety Precautions on page 57.

### Front Wheel Removal

1. Raise the front wheel off the ground by placing a support block under the engine.
2. Remove the speedometer cable (1) by pushing the tab.
3. Remove the axle nut (2).
4. Remove the axle (3) and the wheel.

Do not depress the brake lever when the wheel is off the motorcycle. The caliper piston will be forced out of the cylinder with subsequent loss of brake fluid. If this occurs, servicing of the brake system will be necessary. See your Honda dealer for this service.

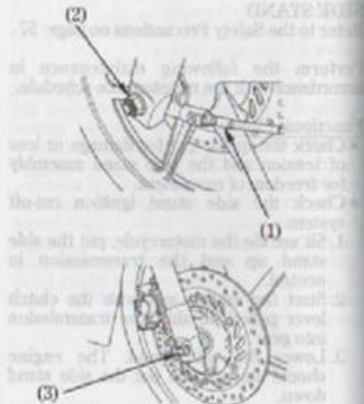

(1) Speedometer cable  
(2) Axle nut  
(3) Axle

### Installation:

Reverse the removal procedure.

1. Insert the axle through the wheel hub and left fork leg.
2. Make sure that the tang (4) on the left front fork leg is located in the speedometer gear box.
3. Tighten the axle nut to specified torque.  
Axle nut torque:  
59 N·m (6.0 kgf·m, 43 lbf·ft)
4. After installing the wheel, apply the brake several times and check for free wheel rotation when released.

If a torque wrench was not used for installation, see your Honda dealer as soon as possible to verify proper assembly. Improper assembly may lead to loss of braking capacity.

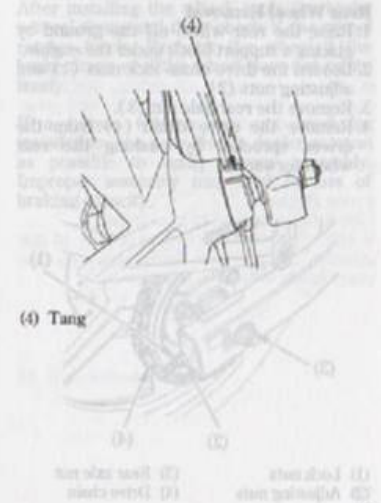

(4) Tang

### Rear Wheel Removal

1. Raise the rear wheel off the ground by placing a support block under the engine.
2. Loosen the drive chain lock nuts (1) and adjusting nuts (2).
3. Remove the rear axle nut (3).
4. Remove the drive chain (4) from the driven sprocket by pushing the rear wheel forward.

5. Remove the axle shaft (5), side collar and rear wheel from the swingarm.

Do not depress the brake pedal while the wheel is off the motorcycle. The caliper piston will be forced out of the cylinder with subsequent loss of brake fluid. If this occurs, servicing of the brake system will be necessary. See your Honda dealer for this service.

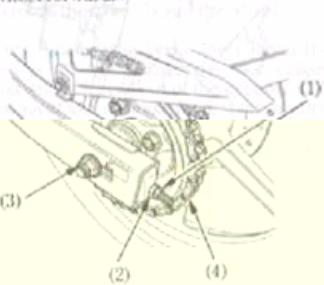

Lock nuts  
Adjusting nuts  
(3) Rear axle nut  
(4) Drive chain

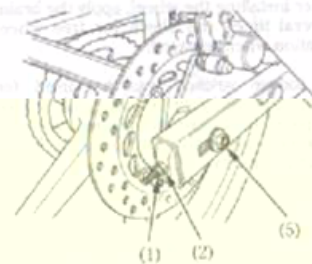

(5) Axle shaft

### Installation:

To install the rear wheel, reverse the removal procedure.

1. Install the axle shaft, side collar and rear wheel to the swingarm.
2. Install the drive chain over the drive sprocket.
3. Install the axle nut.
4. Adjust the drive chain (page 76).
5. Tighten the axle nut to the specified torque:  
59 N·m (6.0 kgf·m, 43 lbf·ft)

When installing the wheel, carefully fit the brake disc between the brake pads to avoid damaging the pads.

After installing the wheel, apply the brake several times and then check if the wheel rotates freely. Recheck the wheel if the brake vibrates or if the wheel does not rotate freely.

If a torque wrench was not used for installation, see your Honda dealer as soon as possible to verify proper assembly. Improper assembly may lead to loss of braking capacity.

### BRAKE PAD WEAR

Refer to the Safety Precautions on page 57.

Brake pad wear depends upon the severity of usage, the type of riding, and road conditions. (Generally, the pads will wear faster on wet and dirty roads.)  
Inspect the pads at each regular maintenance interval (page 50).

### Front Brake

Check the grooves (1) in each pad. If either pad is worn to the bottom of the grooves, replace both pads as a set. See your Honda dealer for this service.

### < FRONT BRAKE >

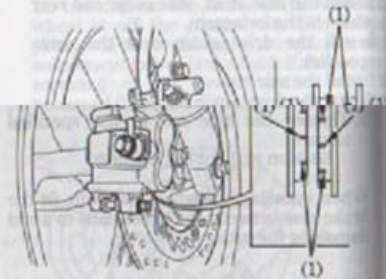

(1) Wear indicator grooves

### Rear Brake

Check the wear indicator mark (2) on each pad.

If either pad is worn to the wear indicator mark, replace both pads as a set. See your Honda dealer for this service.

### < REAR BRAKE >

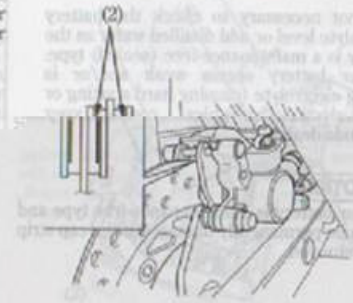

(2) Wear indicator mark

### BATTERY

Refer to the Safety Precautions on page 57.

It is not necessary to check the battery electrolyte level or add distilled water as the battery is a maintenance-free (sealed) type. If your battery seems weak and/or is leaking electrolyte (causing hard starting or other electrical troubles), contact your Honda dealer.

### NOTICE

Your battery is a maintenance-free type and can be permanently damaged if the cap strip is removed.

### ⚠ WARNING

The battery gives off explosive hydrogen gas during normal operation.

A spark or flame can cause the battery to explode with enough force to kill or seriously hurt you.

Wear protective clothing and a face shield, or have a skilled mechanic do the battery maintenance.

### Battery Removal

The battery (5) is in the battery box under the front seat.

1. Remove the front seat (page 37).
2. Remove the clip (1) and open the battery cover (2).
3. Disconnect the negative (-) terminal lead (3) from the battery first, then disconnect the positive (+) terminal lead (4).
4. Pull out the battery (5) from the battery box.

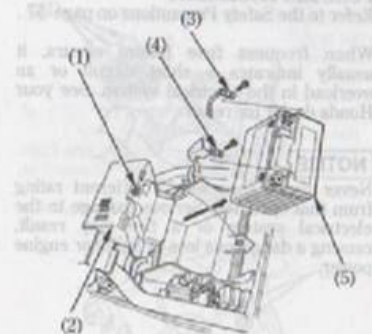

(1) Clip  
(2) Battery cover  
(3) Negative (-) terminal lead  
(4) Positive (+) terminal lead  
(5) Battery

### FUSE REPLACEMENT

Refer to the Safety Precautions on page 57 .

When frequent fuse failure occurs, it usually indicates a short circuit or an overload in the electrical system. See your Honda dealer for repair.

#### NOTICE

Never use a fuse with a different rating from that specified. Serious damage to the electrical system or a fire may result, causing a dangerous loss of lights or engine power.

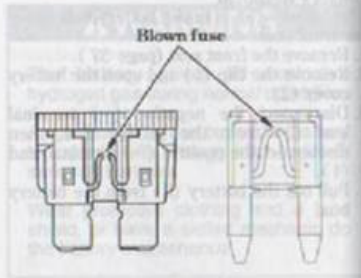

### Fuse Box:

The fuse box is located under the front seat. The specified fuses are:

- 10A
1. Remove the front seat (page 37 ).
2. Open the battery cover (page 89 ) and fuse box covers (1).
3. Pull out the old fuse and install a new fuse. The spare fuses (2) are attached to the battery cover.
4. Close the fuse box cover, battery cover and install the front seat.

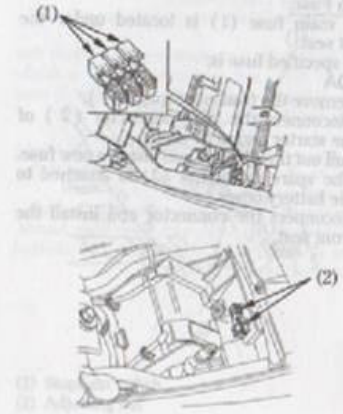

- (1) Fuse box covers
- (2) Spare fuses

### Main Fuse:

The main fuse (1) is located under the front seat.

The specified fuse is:  
30A

1. Remove the front seat (page 37 ).
2. Disconnect the wire connector (2) of the starter magnetic switch.
3. Pull out the old fuse and install a new fuse. The spare main fuse (3) is attached to the battery cover.
4. Reconnect the connector and install the front seat.

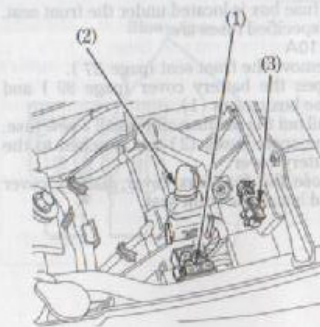

- (1) Main fuse
- (2) Wire connector
- (3) Spare main fuse

### STOPLIGHT SWITCH ADJUSTMENT

Refer to the Safety Precautions on page 57 .

Check the operation of the rear stoplight switch (1) at the right side behind the engine from time to time. Adjustment is done by turning the adjusting nut (2). Turn the nut in the direction (A) if the switch operates too late and in direction (B) if the switch operates too soon.

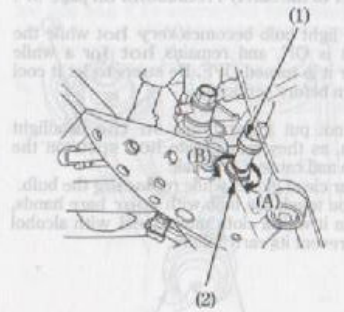

- (1) Stoplight switch
- (2) Adjusting nut

- (1) Dust cover
- (2) Socket
- (3) Pin
- (4) Headlight bulb

### BULB REPLACEMENT

Refer to the Safety Precautions on page 57.

The light bulb becomes very hot while the light is ON, and remains hot for a while after it is turned OFF. Be sure to let it cool down before servicing.

Do not put finger prints on the headlight bulb, as they may create hot spots on the bulb and cause it to break. Wear clean gloves while replacing the bulb. If you touch the bulb with your bare hands, clean it with a cloth moistened with alcohol to prevent its early failure.

- Be sure to turn the ignition switch OFF when replacing the bulb.
- Do not use bulbs other than those specified.
- After installing a new bulb, check that the light operates properly.



### Headlight Bulb

1. Remove the dust cover (1).
2. Remove the socket (2) while pressing down on the pin (3).
3. Remove the headlight bulb (4) by slightly pressing and turning it counterclockwise.



### Position Light Bulb

1. Remove the two screws (1) and pull out front center lower cowl (2).
2. Pull out the socket (3) without turning.
3. Pull out the bulb (4) without turning.
4. Install a new bulb in the reverse order of removal.

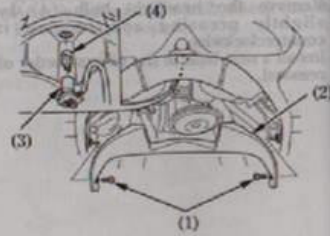

### Stop/Taillight Bulb

1. Remove the rear seat (page 38).
2. Remove the bolt (1).
3. Remove the stop/taillight assembly (2).
4. Turn the socket (3) counterclockwise.
5. Slightly press the bulb (4) and turn it counterclockwise.
6. Install a new bulb in the reverse order of removal.



- (1) Bolt  
(2) Stop/taillight assembly

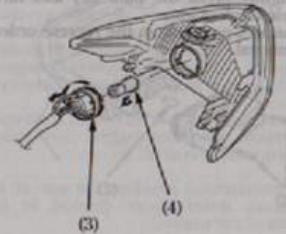

- (1) Remove light base  
(2) Socket  
(3) Socket  
(4) Bulb

### Front/Rear Turn Signal Bulb

1. Remove the turn signal lens (1) and the lens packing (4) by removing the screw (2).
2. Slightly press the bulb (3) and turn it counterclockwise.
3. Install a new bulb in the reverse order of removal.

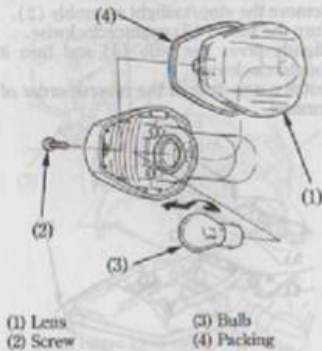

(1) Lens  
(2) Screw  
(3) Bulb  
(4) Packing

### License Light Bulb

1. Remove the license light lens (1) by removing the screws (2).
2. Pull out the bulb (3) without turning.
3. Install a new bulb in the reverse order of removal.

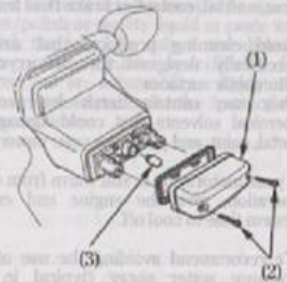

(1) License light lens  
(2) Screws  
(3) Bulb

## CLEANING

Clean your motorcycle regularly to protect the surface finishes and inspect for damage, wear, and oil, coolant or brake fluid leakage.

Avoid cleaning products that are not specifically designed for motorcycle or automobile surfaces.

They may contain harsh detergents or chemical solvents that could damage the metal, paint, and plastic on your motorcycle.

If your motorcycle is still warm from recent operation, give the engine and exhaust system time to cool off.

We recommend avoiding the use of high pressure water, soap, (typical in coin-operated car washes).

### NOTICE

High pressure water (or air) can damage certain parts of the motorcycle.

### Washing the motorcycle

1. Rinse the motorcycle thoroughly with cool water to remove loose dirt.
2. Clean the motorcycle with a sponge or soft cloth using cool water.  
Avoid directing water to muffler outlets and electrical parts.
3. Clean the plastic parts using a cloth or sponge dampened with a solution of mild detergent and water. Rub the soiled area gently rinsing it frequently with fresh water.  
Take care to keep brake fluid or chemical solvents off the motorcycle.  
They will damage the plastic and painted surfaces.

The inside of the headlight lens may be clouded immediately after washing the motorcycle. Moisture condensation inside the headlight lens will disappear gradually by lighting the headlight in high beam. Run the engine while keeping the headlight on.

4. After cleaning, rinse the motorcycle thoroughly with plenty of clean water. Strong detergent residue can corrode alloy parts.
5. Dry the motorcycle, start the engine, and let it run for several minutes.
6. Test the brakes before riding the motorcycle. Several applications may be necessary to restore normal braking performance.
7. Lubricate the drive chain immediately after washing and drying the motorcycle.

Braking efficiency may be temporarily impaired immediately after washing the motorcycle. Anticipate longer stopping distance to avoid a possible accident.

### Finishing Touches

After washing your motorcycle, consider using a commercially-available spray cleaner/polish or quality liquid or paste wax to finish the job. Use only a non-abrasive polish or wax made specifically for motorcycles or automobiles. Apply the polish or wax according to the instructions on the container.

## CLEANING

### Removing Road Salt

The salt contained in the road surface freezing prevention medicine which a road was sprayed with in winter, and the seawater becomes the cause, which rust occurs in.

Wash your motorcycle by the following point after it runs through such a place.

1. Clean the motorcycle using cool water (page 100).

Do not use warm water.  
This worsens the effect of the salt.

2. Dry the motorcycle and the surface of the metal is protected with the wax.

### NOTICE

High pressure water for oil and damage certain parts of the motorcycle.

### Painted Aluminum Wheel Maintenance

Aluminum may corrode from contact with dirt, mud, or road salt. Clean the wheels after riding through any of these substances. Use a wet sponge and mild detergent. Avoid stiff brushes, steel wool, or cleaners containing abrasives or chemical compounds.

After washing, rinse with plenty of water and dry with a clean cloth.

Apply touch-up paint to the wheels where damage has resulted.

Wash the wheels with plenty of water. The inside of the fenders should be cleaned immediately after washing the motorcycle. Moisture accumulation inside the headlight may not disappear gradually by turning the headlight on high beam. Run the engine while keeping the headlight on.

### Exhaust Pipe And Muffler Maintenance

The exhaust pipe and muffler is stainless steel but may become stained by mud or dust.

To remove mud or dust, use a wet sponge and a liquid kitchen abrasive, then rinse well with clean water. Dry with chamois or a soft towel.

If necessary, remove heat stains by using a commercially available fine texture compound. Then rinse by the same manner as removing mud or dust.

- Wash the engine several times to distribute the oil.
- Reinstall the spark plug and spark plug cap.

## STORAGE GUIDE

Extended storage, such as for winter, requires that you take certain steps to reduce the effects of deterioration from non-use of the motorcycle. In addition, necessary repairs should be made BEFORE storing the motorcycle; otherwise, these repairs may be forgotten by the time the motorcycle is removed from storage.

1. Change the engine oil.  
2. Make sure the cooling system is filled with a 50/50 antifreeze solution.  
3. Empty the fuel tank into an approved petrol container using a commercially available hand siphon or an equivalent method. Spray the inside of the tank with an aerosol rust-inhibiting oil.  
Reinstall the fuel fill cap on the tank.

If storage will last more than one month, carburetor draining is very important, to assure proper performance after storage.

## STORAGE GUIDE

Extended storage, such as for winter, requires that you take certain steps to reduce the effects of deterioration from non-use of the motorcycle. In addition, necessary repairs should be made BEFORE storing the motorcycle; otherwise, these repairs may be forgotten by the time the motorcycle is removed from storage.

### STORAGE

1. Change the engine oil.
2. Make sure the cooling system is filled with a 50/50 antifreeze solution.
3. Empty the fuel tank into an approved petrol container using a commercially available hand siphon or an equivalent method. Spray the inside of the tank with an aerosol rust-inhibiting oil.  
Reinstall the fuel fill cap on the tank.

If storage will last more than one month, carburetor draining is very important, to assure proper performance after storage.

## WARNING

Petrol is highly flammable and explosive. You can be burned or seriously injured when handling fuel.

- Stop the engine and keep heat, sparks, and flame away.
- Refuel only outdoors.
- Wipe up spills immediately.

## SPECIFICATIONS

4. To prevent rusting in the cylinder, perform the following:

- Remove the spark plug cap from the spark plug. Using tape or string, secure the cap to any convenient plastic body part so that it is positioned away from the spark plug.
- Remove the spark plug from the engine. Do not connect the spark plug to the spark plug cap.
- Pour a tablespoon (15-20 cm<sup>3</sup>) of clean engine oil into the cylinder and cover the spark plug hole with a piece of cloth.
- Crank the engine several times to distribute the oil.
- Reinstall the spark plug and spark plug cap.

5. Remove the battery. Store in an area protected from freezing temperatures and direct sunlight.  
Slow charge the battery once a month.
6. Wash and dry the motorcycle. Wax all painted surfaces. Coat chrome with rust-inhibiting oil.
7. Lubricate the drive chain (page 79).
8. Inflate the tyres to their recommended pressures. Place the motorcycle on blocks to raise both tyres off the ground.
9. Cover the motorcycle (don't use plastic or other coated materials) and store in an unheated area, free of dampness with a minimum of daily temperature variation. Do not store the motorcycle in direct sunlight.

Operator and two passengers

## STORAGE GUIDE

### REMOVAL FROM STORAGE

1. Uncover and clean the motorcycle.
2. Change the engine oil if more than 4 months have passed since the start of storage.
3. Charge the battery as required. Install the battery.
4. Drain any excess aerosol rust-inhibiting oil from the fuel tank. Fill the fuel tank with fresh petrol.
5. Perform all Pre-ride Inspection checks (page 43).
6. Test ride the motorcycle at low speeds in a safe riding area away from traffic.

## SPECIFICATIONS

### DIMENSIONS

Overall length	1,920 mm (75.6 in)
Overall width	675 mm (26.6 in)
Overall height	1,070 mm (42.1 in)
Wheelbase	1,295 mm (51.0 in)
Ground clearance	172 mm (6.8 in)

### WEIGHT

Dry weight	116.0 kg (255.7 lbs)
------------	----------------------

### CAPACITIES

Engine oil	After draining	1.0 l (1.1 US qt, 0.9 Imp qt)
	After disassembly	1.3 l (1.4 US qt, 1.1 Imp qt)
Fuel tank		10.0 l (2.64 US gal, 2.20 Imp gal)
Cooling system capacity		0.72 l (0.76 US qt, 0.63 Imp qt)
Passenger capacity		Operator and one passenger

## ENGINE

Bore and stroke	58 × 47.2 mm (2.28 × 1.86 in)
Compression ratio	11.0 : 1
Displacement	124.7 cm <sup>3</sup> (7.61 cu-in)
Spark plug	
Standard	CR8E (NGK) or U24ESR-N (DENSO)
For extended high speed riding	CR9E (NGK) or U27ESR-N (DENSO)
Spark plug gap	0.70–0.80 mm (0.028–0.031 in)
Idle speed	1,400 ± 100 min <sup>-1</sup> (rpm)
Valve clearance (Cold)	Intake 0.06 mm (0.002 in) Exhaust 0.27 mm (0.011 in)

## CHASSIS AND SUSPENSION

Caster	25°
Trail	88 mm (3.5 in)
Tyre size, front	80/90–17M/C 44P
Tyre size, rear	100/80–17M/C 52P

## POWER TRANSMISSION

Primary reduction	3.350
Gear ratio, 1st	3.083
2nd	1.941
3rd	1.500
4th	1.227
5th	1.041
6th	0.923
Final reduction	2.800

## ELECTRICAL

Battery	12V - 5AH
Generator	0.230 kW/5,000 min <sup>-1</sup> (rpm)

## LIGHTS

Headlight	12V - 35/35W × 2
Brake/tail light	12V - 21/5W × 2
Turn signal light	Front 12V - 21W
	Rear 12V - 21W
Neutral indicator	12V - 1.7W
Turn signal indicator	12V - 1.7W
High beam indicator	12V - 1.7W
License light	12V - 5W

## FUSE

Main fuse	30A
Other fuses	10A

## CATALYTIC CONVERTER

This motorcycle is equipped with a catalytic converter.

The catalytic converter contains precious metals that serve as catalysts, promoting chemical reactions to convert the exhaust gasses without affecting the metals.

The catalytic converter acts on HC, CO, and NOx. A replacement unit must be an original Honda part or its equivalent.

The catalytic converter must operate at a high temperature for the chemical reactions to take place. It can set on fire any combustible materials that come near it. Park your motorcycle away from high grasses, dry leaves, or other flammables.

A defective catalytic converter contributes to air pollution, and can impair your engine's performance. Follow these guidelines to protect your motorcycle's catalytic converter.

- Always use unleaded petrol. Even a small amount of leaded petrol can contaminate the catalyst metals, making the catalytic converter ineffective.
- Keep the engine tuned-up.
- Have your motorcycle diagnosed and replaced if it is misfiring, backfiring, stalling or otherwise not running properly.